



NLC Snap-In PIR Motion Sensor - Bluetooth® Mesh

HIGHLIGHTS

- Snap-in PIR Motion Sensor for Network Lighting Controls (NLC) using SIG Qualified Bluetooth® mesh
- Designed for use with EiKO Snap-in receptacles for quick and easy installation in the field
- The free iOS/Android App powered by Silvair is used for onsite commissioning which includes setting up areas/grouping/zoning, creating profiles which includes setting high and low end trim, as well as personal control
- The Web App powered by Silvair is used for optional offsite pre-planning which includes setting up areas/grouping/zoning (pre-commissioning not required) and creating profiles (includes setting high and low end trim, occupancy or vacancy, daylight harvesting and time delay)
- No hubs, gateway, or routers are required to make a complete mesh network. The unit can pair with an iOS/Android App to allow initial setup and subsequent adjustments.
- Easily incorporate additional BLE devices like wall/wireless controllers, sensors, fixture controllers, range extenders, and timekeepers
- Over-the-air Firmware upgrade available via iOS/Android App
- A device that is part of EiKO's NLC System

CERTIFICATIONS

- UL listed for US & Canada
- RoHS Compliant
- FCC Compliant
- IP20 Rated
- Damp Location Rated

PERFORMANCE

- Onboard Omnidirectional Antenna
- Operational frequency: 2.4 GHz - 2.483 GHz
- Communication range of Max 65ft*
- 360° Coverage Pattern
- Continuous and Bi-Level Dimming

ELECTRICAL

- Input voltage: 12-24VDC
- Input current: 50mA
- 0-10V Dimming

THERMAL

- 32°F to 113°F (-0°C to 45°C) ambient operating temperature

CONSTRUCTION

- White plastic housing
- Snap-in installation

COMPATIBILITY

- Fixtures: CSX1, CSXR1, VL1, and VLR1; Factory MOD: VOLR and STR

WARRANTY

- 5-Year limited warranty available [online](#). Contact your EiKO sales rep for additional details.

AVAILABLE MODEL

ORDER	ORDER CODE	ITEM #	INPUT VOLTAGE	SENSOR TECHNOLOGY	DAYLIGHT HARVESTING	WIRELESS TECHNOLOGY	DIMMING	MOUNTING HEIGHT	COMMUNICATION RANGE*	INSTALLATION TYPE
	13245	SENA-WHPA	12-24VDC	PIR	Yes	Bluetooth® SIG Mesh	0-10V	8 - 12ft	Max 65ft	Snap-in

* Communication range highly depends on the intergrated fixtures, surrounding environment, and conditions. It is recommended to conduct testing in each unique application for range accuracy.

project name	type
catalog number	voltage
approved by	date



APPLICATIONS

- Offices
- Classrooms
- Restrooms
- Hallways
- Storage Rooms

COMPATIBLE NETWORKED LIGHTING (BLE) DEVICES

ORDER	ORDER CODE	ITEM #	DESCRIPTION
	12635	PSC-DM-WS-100-BLE-SR	BLE TruBlu 120-277V, Single Gang Single Button Wall Controller, White, Parameters set by Silvoir App.
	12636	PSC-DM-I-WS-100-BLE-SR	BLE TruBlu PIR Occupancy/ Vacancy Sensor, 120-277V, Single Gang Wall Controller, White, Parameters set by Silvoir App.
	12637	PSC-DM-WS-400-BLE-SR	BLE TruBlu 120-277V, Single Gang 4-Button Wall Controller, White, Parameters set by Silvoir App.
	12654	ESRPB-W-EO	BLE Easyfit by EnOcean wireless self-powered kinetic Single rocker pad, white, wall plate included.
	12655	EDRPB-W-EO	BLE Easyfit by EnOcean wireless self-powered kinetic Double rocker pad, white, wall plate included.
	12994	PSC-RET-100-BLE-SR	BLE TruBlu Range Extender 120-277V 800ft Nema 4x Outdoor Enclosure
	12933	PSC-TKP-200-BLE-SR	BLE TruBlu Battery Backup Timekeeper and Range Extender, 120V, 800ft, Nema 4X Outdoor Enclosure

PRODUCT DIMENSIONS

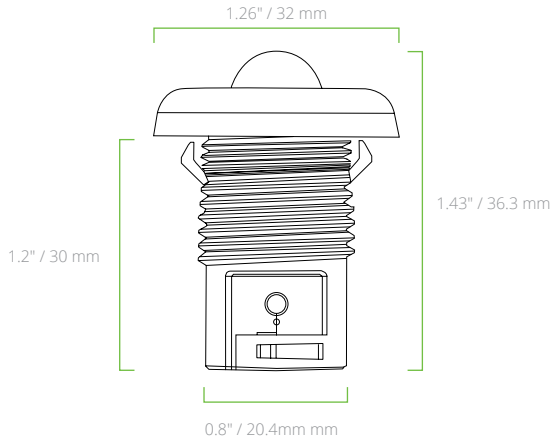

PIN DESCRIPTION

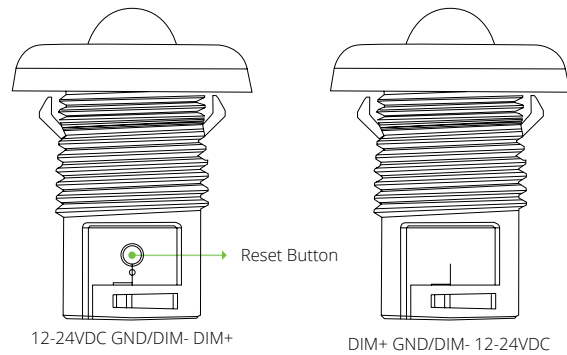

SENA-WHPA

SENSOR DETECTION COVERAGE

COVERAGE SIDE VIEW

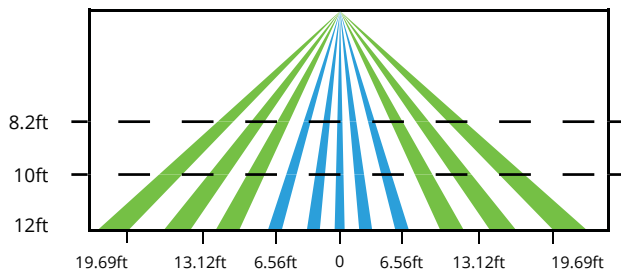

OVERAGE TOP VIEW

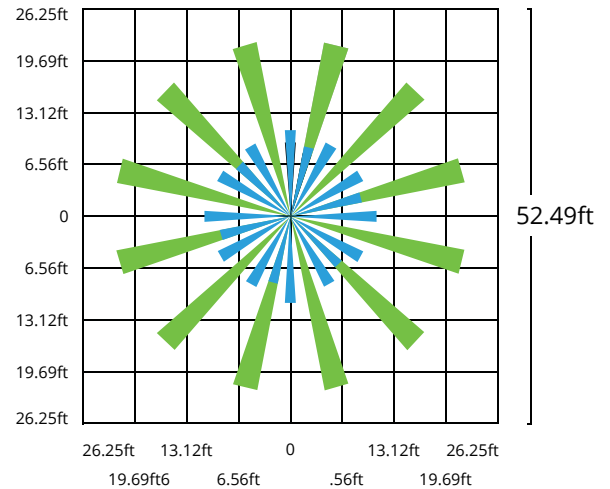

The detection area for movement sensor can be roughly divided into two parts:

- Slow movement (person moving < 1.0'/s)
- Quick movement (person moving > 1.3'/s)

INSTALLATION INSTRUCTIONS

1. Take a flat head screwdriver and gently pry open the sensor cover.

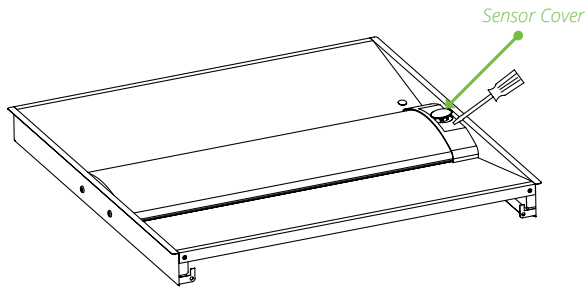

2. Disconnect the sensor harness from the sensor cover and plug it into the sensor.

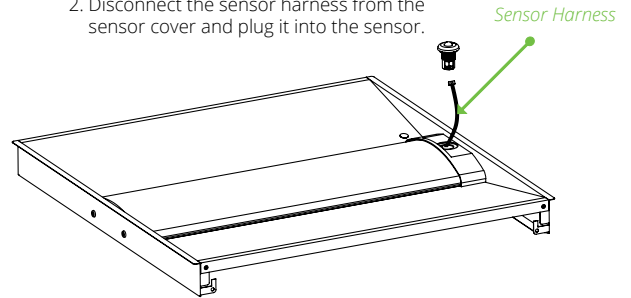

3. Align the sensor with the sensor bracket and firmly push the sensor in place until it snaps securely.

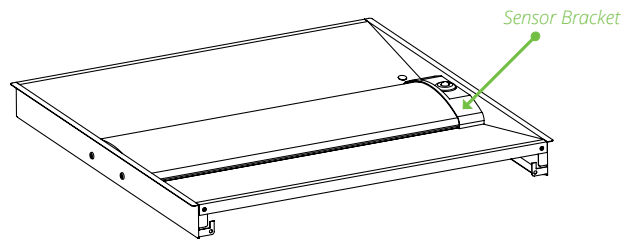

PAIRING AND COMMISSIONING:

Please refer to the Silvair Commissioning User Manual for pairing and commissioning instructions.

Download it at https://silvair-documents.s3.eu-west-1.amazonaws.com/SN-200_Silvair_Commissioning_user_manual.pdf or scan the QR code below.



To access Silvair apps.

Mobile App: Silvair on the App Store and Google Play



Web App: platform.silvair.com



RESETTING A PAIRED SENSOR:

1. Place Magnet or Press Reset Key: With the sensor powered on, place a strong magnet on the top of the sensor or press and hold the reset key located behind the sensor for about 5 seconds.
2. Confirm Reset: The LED Fixture will blink twice, indicating the sensor has been successfully reset.

FCC STATEMENT:

- This device complies with Part 15 of the FCC Rules. Operation is subject to the following two conditions:
 - (1) This device may not cause harmful interference.
 - (2) This device must accept any interference received, including interference that may cause undesired operation.
- This device complies with Part 15 of the FCC Rules. Operation is subject to the following two conditions: (1) this device may not cause harmful interference, and (2) this device must accept any interference received, including interference that may cause undesired operation.
- **Caution:** The user is cautioned that changes or modifications not expressly approved by the party responsible for compliance could void the user's authority to operate the equipment. Note: This equipment has been tested and found to comply with the limits for a Class B digital device, pursuant to part 15 of the FCC Rules. These limits are designed to provide reasonable protection against harmful interference in a residential installation. This equipment generates uses and can radiate radio frequency energy and, if not installed and used in accordance with the instructions, may cause harmful interference to radio communications. However, there is no guarantee that interference will not occur in a particular installation. If this equipment does cause harmful interference to radio or television reception, which can be determined by turning the equipment off and on, the user is encouraged to try to correct the interference by one or more of the following measures:
 - Reorient or relocate the receiving antenna.
 - Increase the separation between the equipment and receiver.
 - Connect the equipment into an outlet on a circuit different from that to which the receiver is connected.
- This device contains licence-exempt transmitter(s)/receiver(s) that comply with Innovation, Science and Economic Development Canada's licence-exempt RSS(s). Operation is subject to the following two conditions:
 - (1) This device may not cause interference.
 - (2) This device must accept any interference, including interference that may cause undesired operation of the device.
- L'émetteur/récepteur exempt de licence contenu dans le présent appareil est conforme aux CNR d'Innovation, Sciences et Développement économique Canada applicables aux appareils radio exempts de licence. L'exploitation est autorisée aux deux conditions suivantes :
 - 1) L'appareil ne doit pas produire de brouillage;
 - 2) L'appareil doit accepter tout brouillage radioélectrique subi, même si le brouillage est susceptible d'en compromettre le fonctionnement.
- To satisfy FCC&IC RF exposure requirements, a separation distance of 20 cm or more should be maintained between the antenna of this device and persons during device operation. To ensure compliance, operations at closer than this distance is not recommended. Les antennes installées doivent être situées de façon à ce que la population ne puisse y être exposée à une distance de moins de 20 cm. Installer les antennes de façon à ce que le personnel ne puisse approcher à 20 cm ou moins de la position centrale de l'antenne.